

Folding Shower Seat, Solid Phenolic, White – L Shaped, 33" [838] wide – Right Hand, ADA

Shower/Tub Accessories

MasterFormat Section 10 28 13

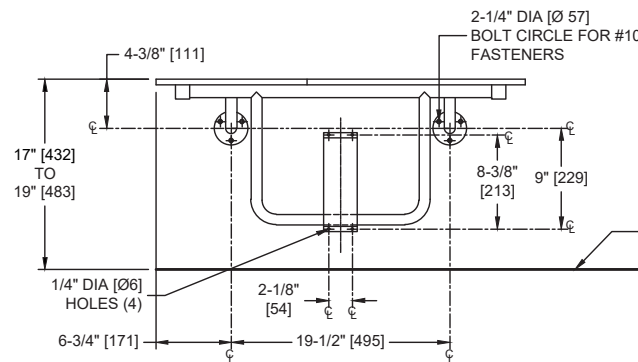
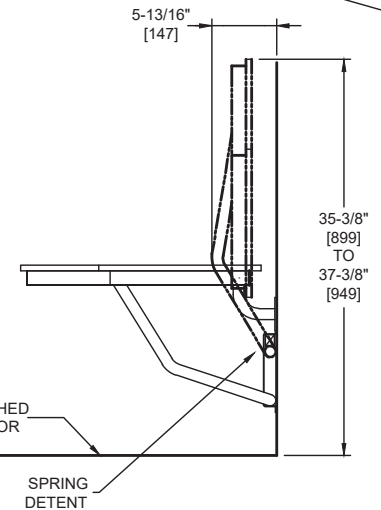
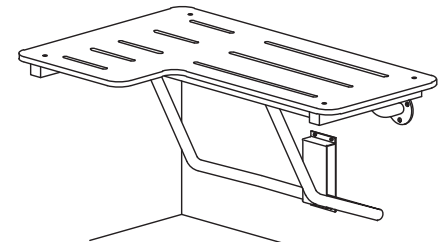
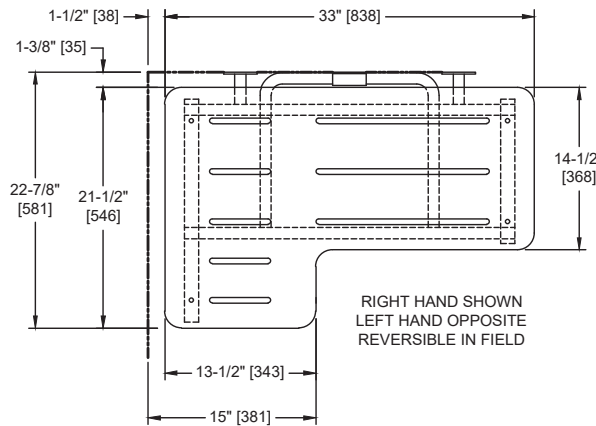

Scan for Information



SUSTAINABILITY/LEED

MR 4.1 (1) MR 6 (1) EQ 4.2 (1)
MR 4.2 (1) EQ 4.1 (1) EQ 4.4 (1)

NOTE:
ALL DIM'S INCH [MM]
ILLUSTRATION FOR REF ONLY AND NTS

PRODUCT OVERVIEW

(Right Hand) Meets 2010 ADA Accessibility Standards and the needs of the physically disabled and elderly. Seat is 1/2" [13] thick, one piece solid, white colored, black core phenolic. Frame, support legs, flanges, and bracket are type 304 satin finish stainless steel. Phenolic seat ONLY is field reversible. Seat measures 33" [838] wide and projects 22-7/8" [581] from wall.

KEY FEATURES & SPECIFICATIONS

- L-Shaped - Right Handed - 33" [838] Wide - ADA Compliant- ADA Compliant
- Slotted Seat (for drainage) folds up when not in use - Requires only one hand operation to manually lower to horizontal position for use or raise for departure and arrival.
- Seat - White Phenolic / Body - Type 304 Stainless Steel
- Support load of 250 lbs to 500 lbs maximum if installed properly
- Surface Mounted
- Seat is Slotted for Drainage
- 33" [838] Wide

OPERATION & MAINTENANCE

Fold-up Shower Seat requires only one hand operation to manually lower to horizontal position for use or raise for departure and arrival. Guide bracket with spring detent prevents seat from dropping and provides positive support in usage position as well as spring locked storage position. Gas charged struts assist opening by allowing slowly lowering seat to operating position from storage and assist closing by self-raising seat from approximately 25° to 85° and providing partial extra push required to achieve fully stored position.

TECHNICAL INFORMATION / PRODUCT PROPERTIES

Property	Value
Dimensions	Fold Down: 33" [838] W x 17" [432] H x 22-7/8" [581] D Fold Up: 33" [457] W x 35-3/8" [899] H x 22-7/8" [581] D
Construction	Seat - White Phenolic / Body - Type 304 Stainless Steel Seat is Slotted for Drainage
Mounting	Surface Mounted
Materials	<p><u> Tubes:</u> 18 gauge (.048" [1,2] thick) type 304 stainless steel, 1" Dia. [Ø25] and 1-1/4" [32] square. Unitized all welded construction. Exposed surfaces are satin finish. Edges and corners are radiused and burr free.</p> <p><u> Flanges:</u> 3/16" [4,8] type 304 stainless steel. Exposed surfaces have satin finish. Edges and corners are radiused and burr free.</p> <p><u> Brackets:</u> 16 gauge (.06" [1,52] thick) type 304 stainless steel. Exposed surfaces are satin finish. Edges and corners are radiused and burr free.</p> <p><u> Seat:</u> Solid Phenolic 5/16" [8] x 20" [508] x 14-1/2" [368]. Exposed surfaces have semi-gloss laminate white colored top and bottom surfaces and shall have black edges. Corners are radiused and burr free. Seat top shall have three (3) slots 1/2" [13] wide x 12" [305] long for water drainage and user slip resistance. Mounting hardware is stainless steel dome head carriage bolts with acorn nuts on bottom.</p> <p><u> Spring:</u>Stainless steel wire type 304 OD 27/32" [Ø21,6] coils x 2-1/4" [57,2] body length x .085" Dia. [Ø2,2] wire.</p>

INSTALLATION

This unit is surface mounted. Installer/contractor must provide concealed anchor plate or blocking as specified in construction documents or as required by local building codes prior to wall finishing. Fasten unit flanges and guide bracket to concealed anchor or blocking plate with appropriate hardware. Note that concealed mounting plates or anchors and hardware are not supplied with this product and must be specified separately. Ensure that mounting configuration complies with local building codes.

CAPACITY
WARRANTY

One (1) Year from date of Invoice